

# Installation Guide

**SPDS2107 + SPDS2117**

**VESA Adapters**

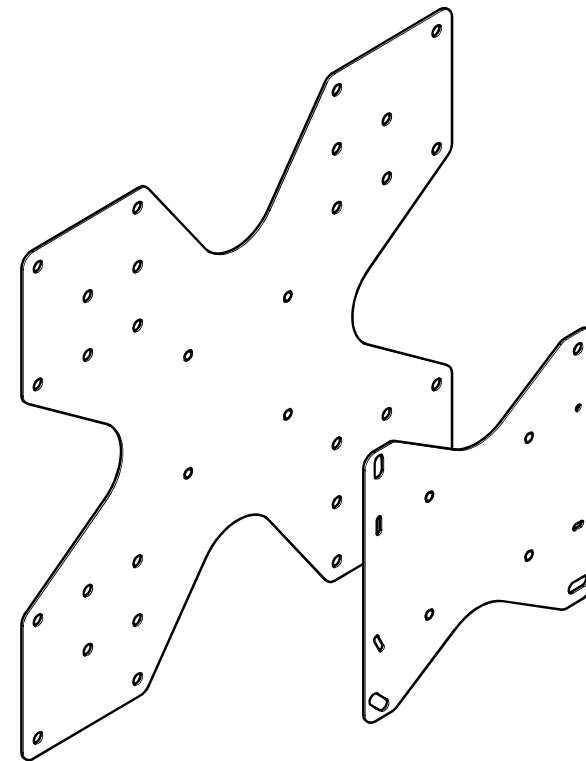



## CAUTION

This product must be installed by a professional installer. It is recommended that more than one person are involved in the installation of this product.

Do not exceed the stated weight limits.  
The maximum weight limit for this product is 150 kg per ceiling pole.

This product is intended for indoor use only.

If these installation instructions are not followed precisely, it could lead to product failure and potential personal injury.

Ergonomic Solutions cannot be held responsible for any failure or injury, if the installation instructions are not followed correctly.

## 1 Mount VESA adapter to screen

SPDS2107: VESA 200  
SPDS2117: VESA 200/300/400

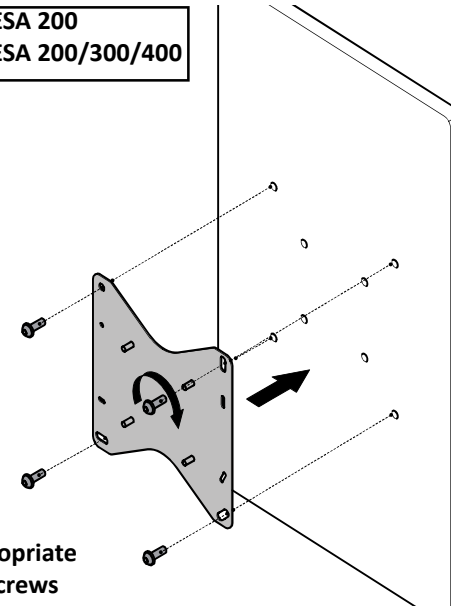

Choose the appropriate length of VESA screws

## Box content

SPDS2107  
VESA 200

SPDS2117  
VESA 200/300/400

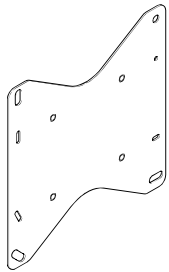



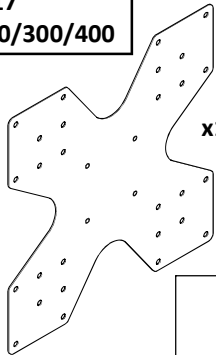



x1



x1

### VESA fixing bag (x4)

-  M8 x 12mm screw
-  M8 x 25mm screw
-  M8 x 35mm screw
-  M8 x 16mm screw
-  M8 x 5mm spacer
-  M8 washer

## 2 Mount VESA adapter and screen on to the ceiling pole

